

04 Furnishing with carpets

If the material, colors and design of a carpet help to determine the style of an ambience, the size certainly determines the overall perception. The choice is naturally conditioned by the space available, but it is also important to evaluate the relationship with the other furnishing components. By way of example, this section outlines some possible layouts for different rooms in the home.

Living room (3), Dining room (7), Bedroom (8)

Living room

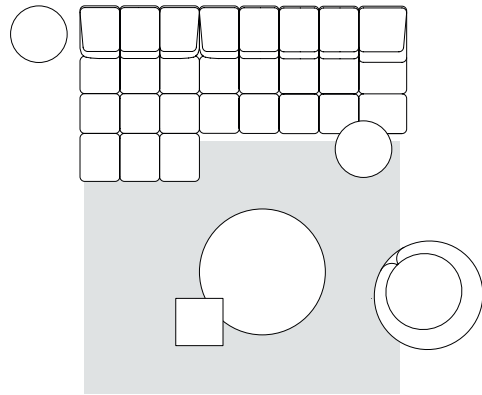

SMALL
200x250cm

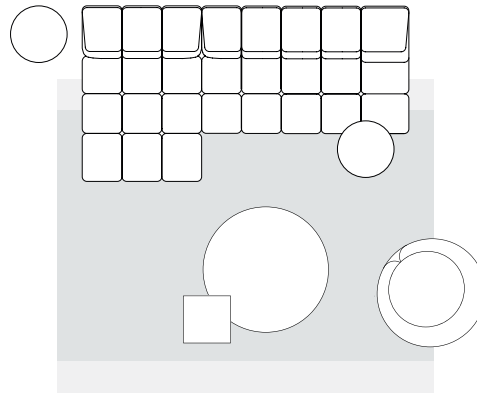

MEDIUM
200x300cm, 250x300cm

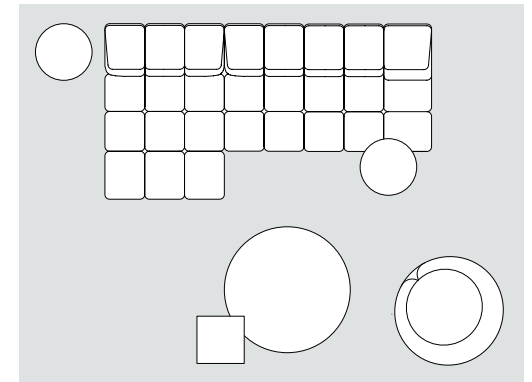

LARGE
300x400cm

Living room

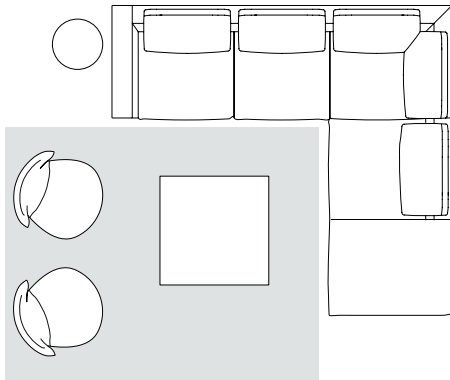

SMALL
200x250cm

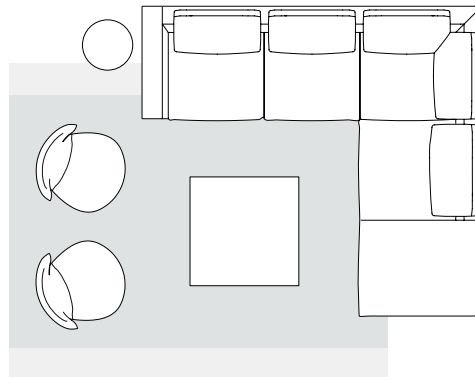

MEDIUM
200x300cm, 250x300cm

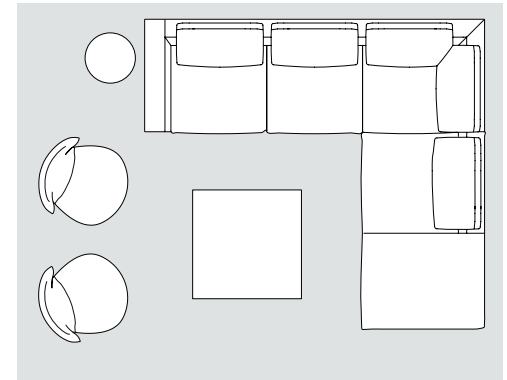

LARGE
300x400cm

Living room

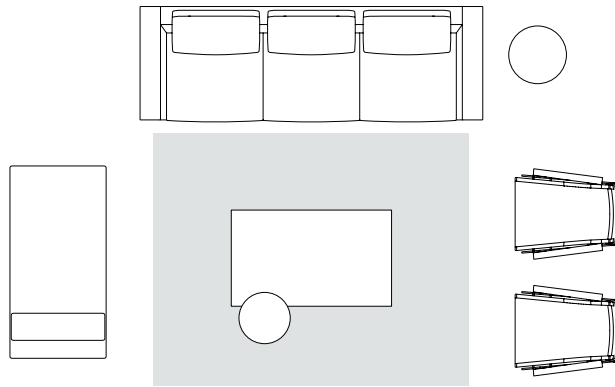

SMALL
200x250cm

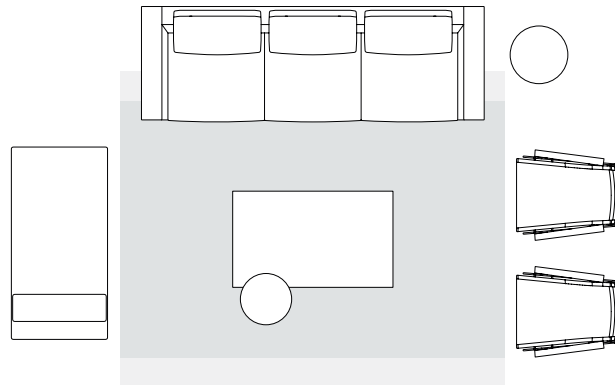

MEDIUM
200x300cm, 250x300cm

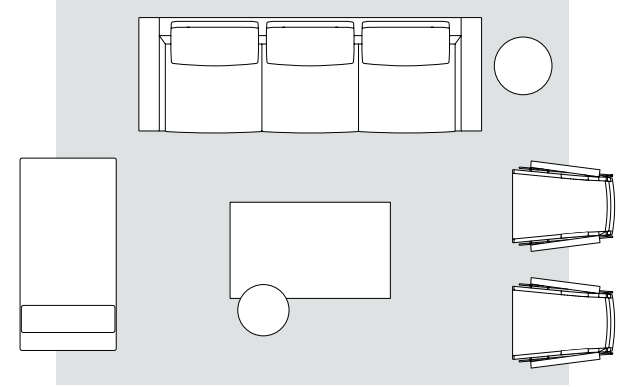

LARGE
300x400cm

Living room

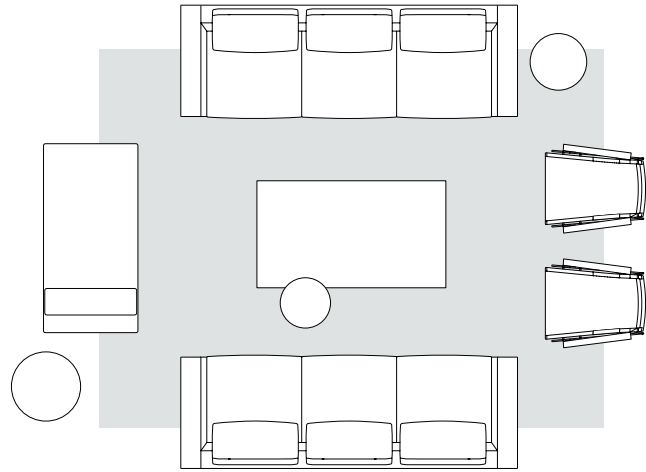

LARGE
300x400cm

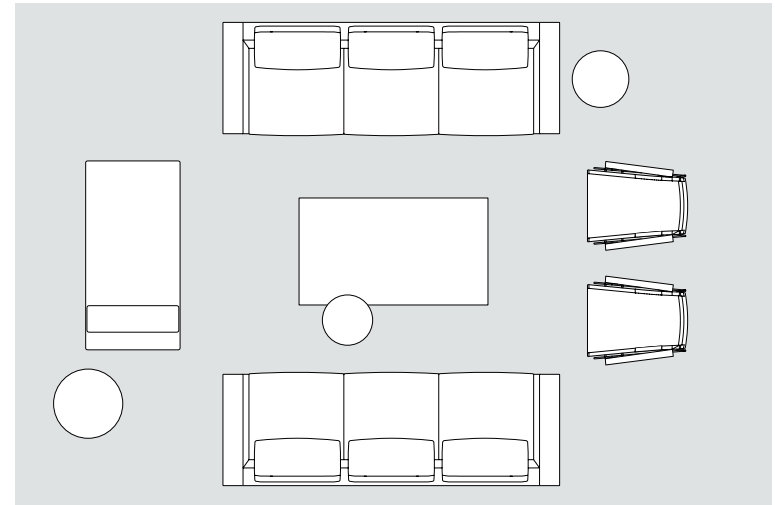

LARGE
400x600cm
(custom made)

Dining room

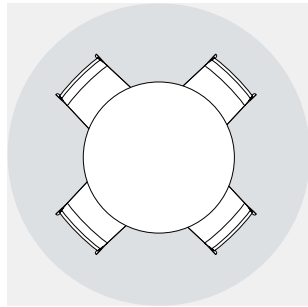

SMALL
Ø 240, 240x240 cm

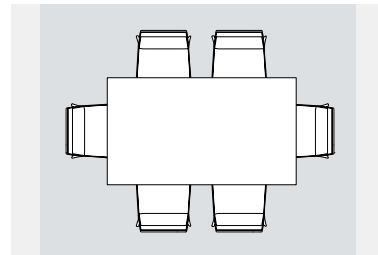

MEDIUM
200x250, 200x300 cm

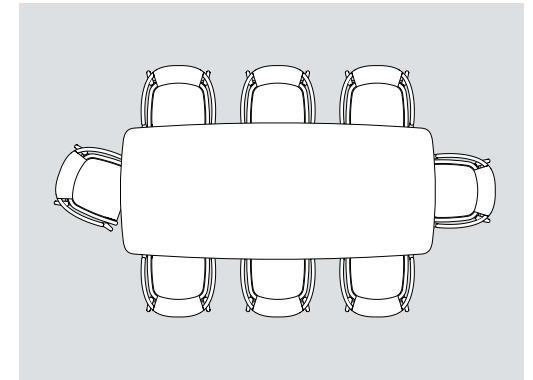

LARGE
250x350cm

Bedroom

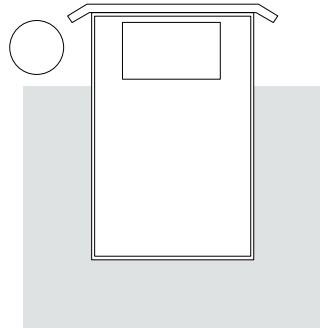

SMALL
200x250cm

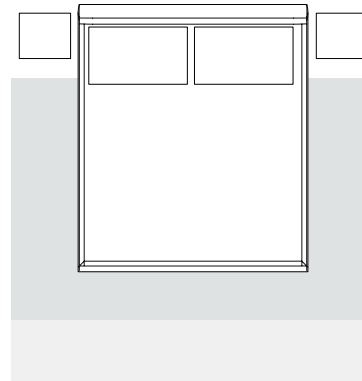

MEDIUM
200x300cm, 250x300cm

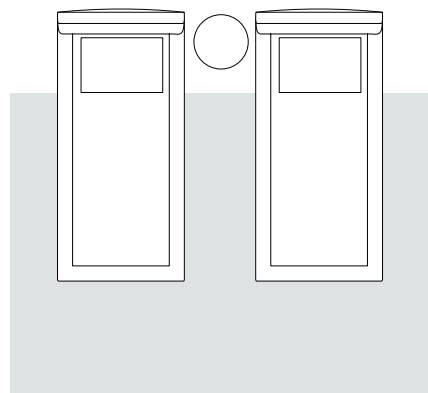

LARGE
250x350cm

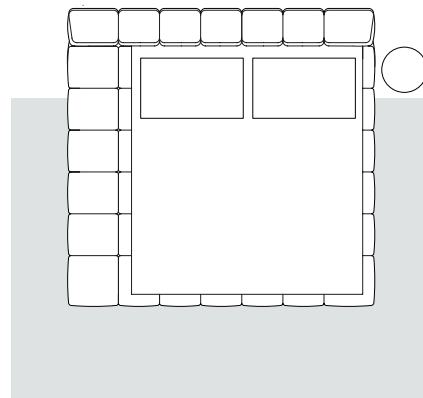

LARGE
250x350cm

